

815DT Smart Differential Pressure Transmitter

The 815DT smart differential pressure transmitter is a rugged, compact, loop powered instrument that is ideally suited for hazardous locations and hostile environments where space is limited. The 815DT offers many industry standard outputs to meet applications where low cost, discrete and continuous monitoring is required or preferred. This versatile instrument may be used to reliably measure differential pressure, level or even flow. Its stainless-steel construction and three-year warranty dramatically reduces the total cost of ownership.

The 815DT is easily configured using HART 7 Communication Protocol and Modbus RTU Serial Communications; it is also very easy to set the zero and span set points with a magnet, as the zero and span magnetic targets are clearly identified on the housing. The SOR® 815DT is a feature rich, low cost, "stick" transmitter that sits at the top of its class.

SOR offers many configurations. If you don't see what you need, we will engineer a solution for your application.



Features

- HART®7 Communication Protocol with 4-20 mA Output
- 1-5 VDC (Low-Power) Mode of Operation Output
- Modbus RTU (RS-485) Serial Communications
- Configurable Normally-Open Solid-State Switch Output (SPST)
- ±0.10% (URL) Accuracy (Continuous Output)
- Zero Balance & URL: ±0.25% URL (Each)
- 316 Stainless Steel, Explosion Proof Housing
- Compact: 2.2 in./55.9 mm Face to Face Dimension
- Hermetically Sealed Leads
- Pressure Ranges: 0-138 in H₂O (0-5 psid) to 0-500 psid
- Turndown: 5 to 1
- Zero and Span Magnetic Targets Located on Housing
- EMC (EMI/RFI) Protection
- NEMA 4X, IP66 Housing
- FM and ATEX in U.S., Canada and Europe
- 3 year Warranty
- Light Weight: 1.8 lbs. (0.8 kg)

HART 
COMMUNICATION PROTOCOL



815DT Smart Differential Pressure Transmitter

Product Specifications

Product Specifications	
Continuous Output	
Accuracy	±0.10% URL (BFSL)
Zero Balance & URL	±0.25% URL (Each)
Turndown	5:1
Output	4-20mA
	HART 7 Communication Protocol
	Modbus RTU (RS-485) Serial Communications
	1-5VDC (Low Power) Mode of Operation
	(36mW ± 5mW @ 10VDC)
Temperature Effect	±1% URL/100°F
	@ -40 to 176°F
Switch Output	
1: Off	
2: Windowed, Normally-Open	
3: Windowed, Normally-Closed	
4: Single Point, Normally-Open	
5: Single Point, Normally-Closed	
6: PWM (Pulse Width Modulation), Pulsed Low	
7: PWM (Pulse Width Modulation), Pulsed High	
8: Dead Band, Normally-Open	
9: Dead Band, Normally-Closed	
Accuracy	±0.25% URL
Type	Normally Open
	Solid State Relay (SPST)
Electrical Rating	30V, 120mA
Temperature Effect	±1% URL/100°F
	@ -40 to 176°F
Temperature Range	
Compensated	-40 to 176°F (-40 to 80°C)
Ambient	-40 to 176°F (-40 to 80°C)
Process	-40 to 194°F (-40 to 90°C)
Storage	-40 to 194°F (-40 to 90°C)
Long Term Stability	≤ ±0.5% URL per year
Response Time	≤ 70 ms
Supply Voltage	10-36VDC
Loop Resistance	667 ohms @ 24VDC
Circuit Protection	Reverse polarity and EMC (EMI/RFI) protected
Construction	316-SST housing (CF8M)
Process Connection	(H & L side)
	1/4" NPT(F)
Electrical Connection	
Size	1/2" NPT(M)
Termination	18 AWG shielded cable, 72-inch length
Wetted Materials	316-SST
(Standard)	(sensor & pressure ports)
Line Pressure	1000 psi max.
Line Pressure Effect on Zero	
5 psi	< 0.8% URL/1000 psi
≥15 psi	< 0.5% URL/1000 psi
*Zeroing the transmitter in conditions of static pressure can eliminate this error.	
Over Pressure	3 times FSPR*
Burst Pressure	4 times FSPR
Weight	1.8 lb (0.8 kg)
Warranty	3 years

Design and specifications are subject to change without notice. For latest revision, see SORInc.com.

*FSPR = Full Scale Pressure Rating

815DT Smart Differential Pressure Transmitter

Switch Operation

The switch output of the 815DT is a Normally Open Solid State Relay rated for 30V, 120mA. It can be configured 9 ways; as shown in the following diagrams. Switch set point(s) and continuous output zero and span points can be set at the factory as specified by the customer.

In all nine configurations, the fail-safe state for the 815DT switch output will be open (i.e., if power is removed from the 815DT, the switch contacts will open automatically).

- ❶ Off
- ❷ Windowed, Normally-Open
- ❸ Windowed, Normally-Closed
- ❹ Single Point, Normally-Open
- ❺ Single Point, Normally-Closed
- ❻ PWM (Pulse Width Modulation), Pulsed Low
- ❼ PWM (Pulse Width Modulation), Pulsed High
- ❽ Dead Band, Normally-Open
- ❾ Dead Band, Normally-Closed

❷ Windowed, Normally-Open

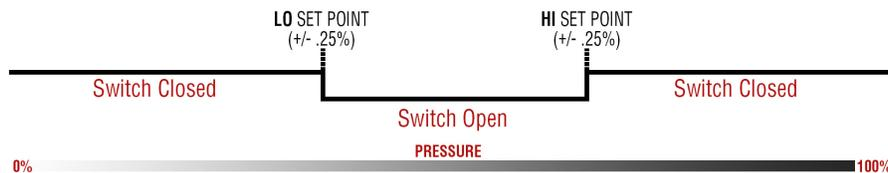

In this configuration, the switch output will be open when the process pressure is within a user selectable range and closed when the pressure is outside of these boundaries. This is designed for applications where there is a known acceptable operating pressure range.

❸ Windowed, Normally-Closed

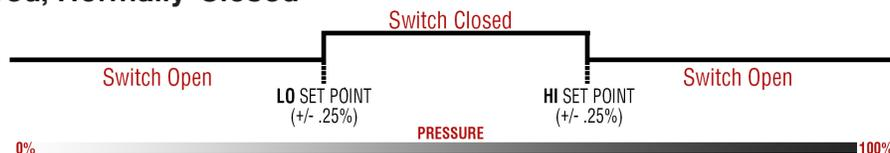

In this configuration, the switch output will be closed when the process pressure is within a user selectable range and open when the pressure is outside of these boundaries. This is designed for applications where there is a known acceptable operating pressure range.

④ Single Point, Normally-Open (Close on Rise/Open on Fall)

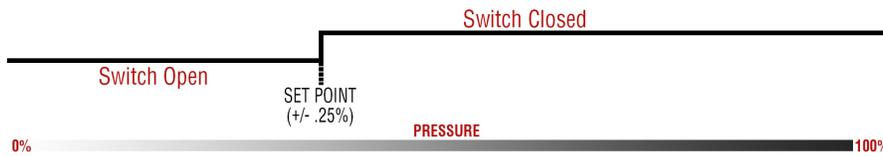

In this configuration, the switch output will be open for pressures less than the selected setpoint. The switch output would then be closed for pressures greater than the setpoint.

⑤ Single Point, Normally-Closed (Open on Rise/Close on Fall)



In this configuration, the switch output will be closed for pressures less than the selected setpoint. The switch output would then be open for pressures greater than the setpoint.

⑥ Pulse Width Modulation - Pulsed Lo

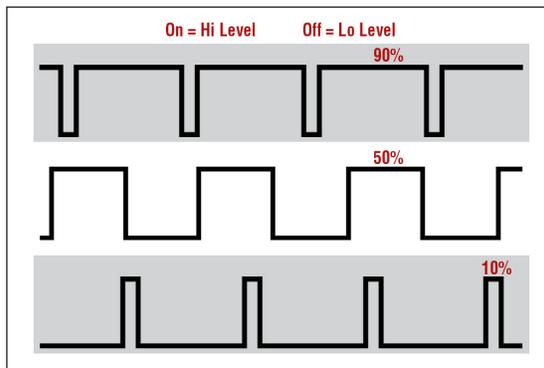

⑦ Pulse Width Modulation - Pulsed Hi

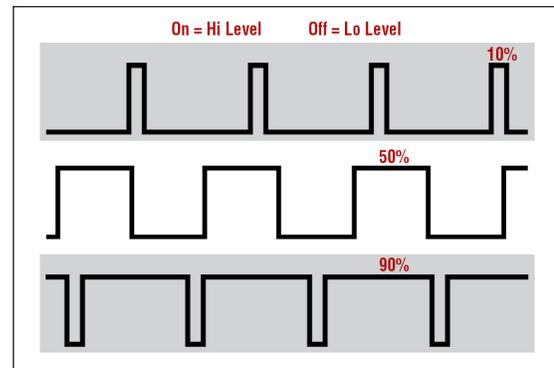

815DT Smart Differential Pressure Transmitter

Switch Operation

8 & 9 Dead Band

This diagram depicts an adjustable dead band. Dead band is the range through which an input can be varied without initiating an observable response. Dead band is usually expressed in percent of span.

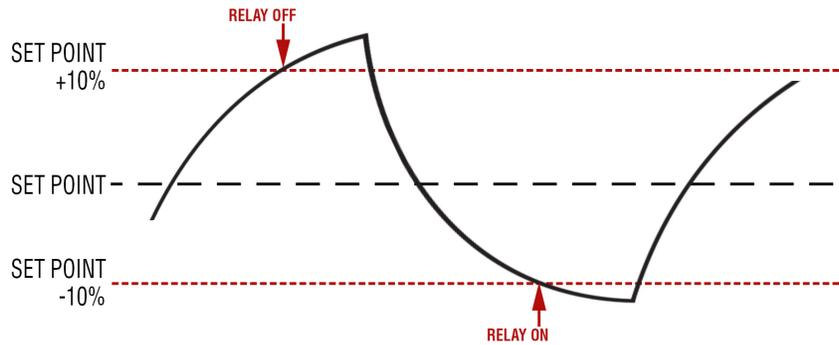

EXAMPLE: A 20% total dead band is applied to the setpoint of a monitored parameter. The relay will turn on and off as indicated in the graph above.

The hysteresis or dead band value is the difference between the points at which the alarm triggers and releases, expressed in the relevant engineering unit. The alarm triggers at the set point, and is cleared at the hysteresis level away from the set point.

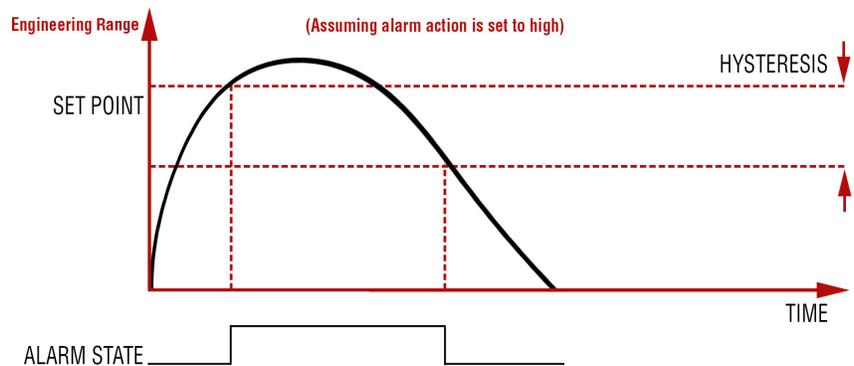

815DT Smart Differential Pressure Transmitter

How to Order

Model Number System (example)

815DT - Z - 24 - D - RR C1

815DT Smart Differential Pressure Transmitter, HART 7 Communication Protocol with 4-20mA Output, Modbus RTU (RS-485) Serial Communications, 1-5 VDC (Low-Power) Mode of Operation, Configurable Solid-State Switch Output, 0-100 psid, 316SS Sensor and Port, 1/4" NPT(F) Differential Process Connection (HI & LO side), and Optional SS Tag Wired to Housing with Customer Specified Information.

		2	Process Connection Size
		D	1/4"NPT(F) Differential Process Connection (HI & LO side)
1			
Range			
0-138 in H ₂ O (0-5 psid)	21		
0-415 in H ₂ O (0-15 psid)	22		
0-50 psid	23		
0-100 psid	24		
0-300 psid	25		
0-500 psid	26		
		3	Accessories
		BB	Cleaned for industrial oxygen service
		DS	Dual Seal approval (FM)*
		PK	Pipe mounting kit
		RR	SS tag wired to housing with customer specified information
		Certificates	
		C1	Calibration
		C2	Hydrostatic Pressure Test
		C3	Inspection Report
		C4	Compliance/Conformance
		C8	Typical Material of Wetted Parts
		D2	Manufacturer's Certification
815DT	Z	24	D
		RR C1	← Model Number (example)

*Dual Seal version is not hermetically sealed.

Agency Approvals

Approved	Safety Method	Approval
FM (U.S. and Canada)	Explosion Proof Hazardous Locations	Class I, II, III; Division 1 Groups A-G; T5; Type 4X
	Non-incendive	Class I, II, III; Division 2 Groups A-G; T5; Type 4X
ATEX	Flameproof	II 2 G Ex d IIC T5 Gb IP 66

815DT Smart Differential Pressure Transmitter

Dimensions

Dimensions shown are for reference only. Contact the factory for certified dimension drawings.
Linear = mm/in.

Drawing 0091544

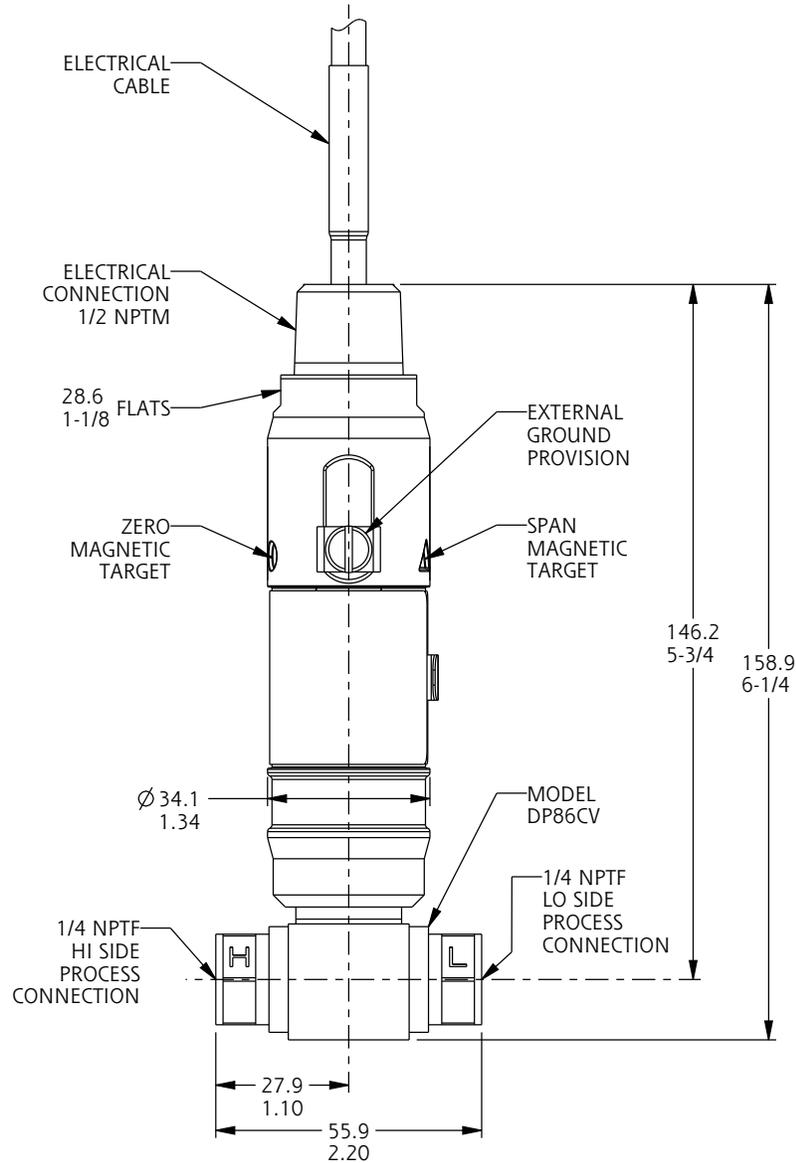



MEASUREMENT AND CONTROL

SOR Inc. | Lenexa, KS USA | 913-888-2630 | Fax 913-888-0767 | SORInc.com

REGIONAL OFFICES

China

SOR China | Beijing, China
+86 (10) 5820 8767 | Fax +86 (10) 58 20 8770

Middle East

SOR Measurement & Control Equipment Trading JLT | Dubai, UAE
+971 4 3699042 | Fax +971 4 3698989